

















OKTO 3 TP GU10

CODE	COULEUR	KLEUR	FARBE	COLOR	Socket	AC	Watt Max	Lamp
TR42305	NOIR MAT	MAT ZWART	SCHWARZ MATT	MATT BLACK	GU10	AC 230V	10W	PAR16 LED
TR42308	NOIR MAT - CHAMPAGNE	MAT ZWART - CHAMPAGNE	SCHWARZ MATT - CHAMPAGNE	MATT BLACK - CHAMPAGNE	GU10	AC 230V	10W	PAR16 LED
TR42306	NOIR MAT - OR ROSE	MAT ZWART - GOUD ROZESCHWARZ MATT - ROSÉ	SCHWARZ MATT - ROSE	MATT BLACK - PINK GOLD	GU10	AC 230V	10W	PAR16 LED
TR42383	NOIR MAT - ROSE	MAT ZWART - ROZE	SCHWARZ MATT - ROSE	MATT BLACK - PINK	GU10	AC 230V	10W	PAR16 LED
TR42330	BLANC MAT	MAT WIT	WEISS MATT	MATT WHITE	GU10	AC 230V	10W	PAR16 LED
TR42349	BLANC MAT - CHAMPAGNE	MAT WIT - CHAMPAGNE	WEISS MATT - CHAMPAGNE	MATT WHITE - CHAMPAGNE	GU10	AC 230V	10W	PAR16 LED
TR42302	BLANC MAT - OR ROSE	MAT WIT - GOUD ROZE	WEISS MATT - ROSÉ	MATT WHITE - PINK GOLD	GU10	AC 230V	10W	PAR16 LED
TR42382	BLANC MAT - ROSE	MAT WIT - ROZE	WEISS MATT - ROSE	MATT WHITE - PINK	GU10	AC 230V	10W	PAR16 LED

F	N	D	E
 Montage en suspension.	Pendelmontage.	Nur für Aufhängmontage.	Suspended mounting only.
 Usage intérieur uniquement.	Alleen voor binnengebruik.	Nur für den Innengebrauch.	Indoor use only.
 Protection contre la pénétration de corps supérieurs à 12mm. Sans protection contre l'eau.	Bescherming tegen het binnendringen van lichaam >12mm. Zonder bescherming tegen water.	Schutz gegen Eindringen von Körpern von mehr als 12mm. Ohne Schutz gegen Wasser.	Protected against the ingress of solid bodies greater 12 mm. No protection against the ingress of liquids.
 Protection contre une énergie de choc de 0,20 Joule.	Bescherming tegen een impact-energie van 0,20 Joule.	Schutz gegen eine Stoßenergie von 0,20 Joule.	Protection against an impact energy of 0,20 Joule.
 Produit dont les parties accessibles sont séparées des parties actives par double isolation ou isolation renforcée.	Product waarvan die toegankelijke delen gescheiden zijn van de actieve delen, door een dubbele of een versterkte isolatie.	Produkt von welchen die zugänglichen Teile getrennt sind von den aktiven Teilen, durch eine doppelte oder eine verstärkte Isolierung.	Live parts are equipped with additional isolation protection, such as reinforced or double insulation.
 Homologation CE.	CE gekeurd.	CE Genehmigung.	Product in conformity CE.
 Testé à 650°.	Getest bij 650°.	Getestet bei 650°.	Test on 650°.
 Installation sur surfaces normalement inflammables.	Installatie op normaal ontvlambare oppervlakken.	Installation auf normal entflammaren Oberflächen.	Suitable for installation on normally flammable surfaces.
 Distance minimale des objets illuminés (0,5 m)	Minimum afstand tot de belichte voorwerpen (0,5 m)	Mindestabstand zu beleuchteten Gegenständen (0,5 m)	Minimum distance from lighted objects (0,5 m)
 Produit sous haute température en fonctionnement. Interdiction d'avoir des objets ou des parois proches pendant toute la durée de dégagement de chaleur. Même après extinction.	Product onder hoge temperatuur bij werking. Verbod voorwerpen of muren nabij te hebben gedurende de hele oververhitting, zelfs na uitdoving.	Produkt unter hoher Temperatur bei Betrieb. Verbot Gegenstände oder Wände in der Nähe zu haben während der ganzen Dauer der Überhitzung, auch nach dem Erlöschen.	Produkt emitting high temperature. Can not be installed too close of walls and objects even after extinction.
 Attention ! Risque d'électrocution. Extinction de la source électrique avant chaque manipulation.	Let op gevaar voor elektrokuteren. Afsluiten van de stroom voor iedere manipulatie.	Achtung Gefahr eines elektrischen Schlags. Stromquelle abschliessen bevor jede Manipulation.	Attention! Risk of electric shock. Switch off before any intervention on the luminaire.
 A connecter à un courant alternatif de 230V.	Aan te sluiten op een AC-circuit van 230V.	An eine AC-Schaltung von 230 Volt an zu schliessen.	To connect to a 230V AC circuit.
 Garantie 3 ans.	3 jaar garantie.	3 Jahre Garantie.	3 years warranty.
 L'appareil doit être éliminé dans des centres de ramassage spécialisés.	Het toestel moet worden afgevoerd in een speciale collectie centra.	Das Gerät muss von einer speziellen Sammelstelle entsorgt werden.	Luminaire must be disposed in specialized collection center.
 Source remplaçable par un end-user.	Lichtbron vervangbaar door eindgebruiker.	Lichtquelle vom Endbenutzer austauschbar.	Replaceable light source by an end-user.
 <ul style="list-style-type: none"> Toutes les sources de chaleur (ampoules, transformateurs, convertisseurs, ...) doivent obligatoirement être suffisamment espacées et ventilées pour empêcher l'incendie. Veuillez nous contacter lors de cas particulier de montage. Ce document doit être conservé pendant toute la durée de vie du produit. Le produit ne sera ni échangé, ni repris en cas d'erreur de montage. INDIGO se réserve le droit de modifier les spécifications sans préavis. <p>Le luminaire doit être monté et installé par un professionnel et il sert uniquement à éclairer.</p>	<ul style="list-style-type: none"> Alle warmtebronnen (lampen, transformatoren, omvormers, ...) moeten voldoende worden geventileerd en op een voldoende afstand zijn om de brand te voorkomen. Neem contact met ons in geval van speciale montage. Dit document moet worden bewaard voor de hele levensduur van het product. Het product wordt nog terug genomen, nog vervangen bij foutieve installatie. INDIGO behoudt zich het recht om specificaties te wijzigen zonder voorafgaande kennisgeving. <p>De armatuur moet worden gemonteerd en geïnstalleerd door vakmensen en dient alleen om te verlichten.</p>	<ul style="list-style-type: none"> Alle Wärmequellen (Lampen, Transformatoren, Umformer, ...) müssen ausreichend belüftet sein und einen genügenden Abstand haben um das Feuer zu verhindern. Bitte kontaktieren Sie uns bei einer speziellen Montage. Dieses Dokument muss für die ganze Lebensdauer des Produkts aufbewahrt Das Produkt wird weder zurückgenommen noch umgetauscht bei falscher Installation. INDIGO behält das Recht für Spezifikationen, ohne vorherige Ankündigung, zu ändern. <p>Die Leuchte darf nur von Fachleuten montiert und installiert werden und dient nur zur Beleuchtung.</p>	<ul style="list-style-type: none"> All heat source (bulbs, transformers, converters, ...) are required to be sufficiently spaced and ventilated to prevent the fire. Please contact us in case of special installation. This document must be kept for the all lifetime of the product. The product can't be returned or exchanged following to installation error. INDIGO reserve the right to modify specifications without prior notice. <p>The fixture should be assembled and installed by professionals and used only to illuminate.</p>

1

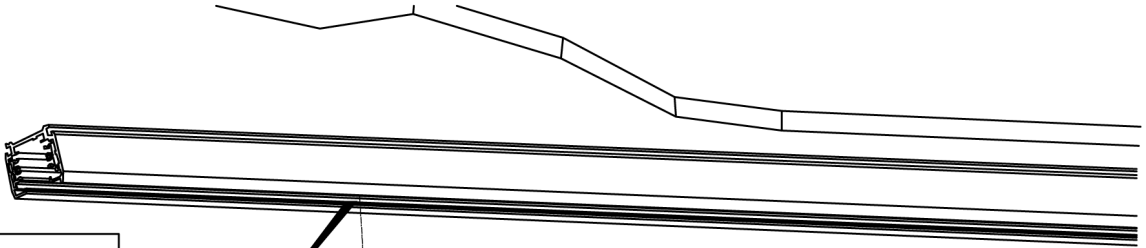
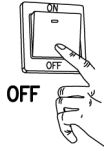

2

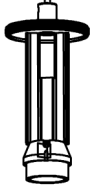

A



B



AC220-240V 50/60Hz

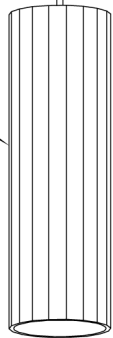
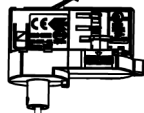

3

A

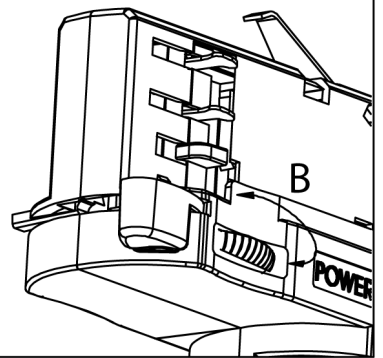

1

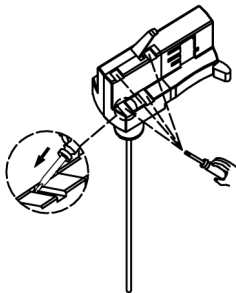

1

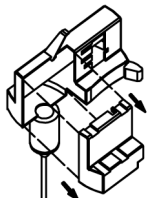

2

2

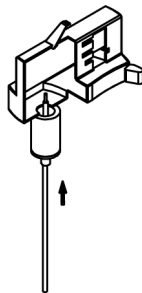

1

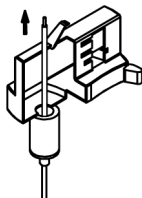

2

3

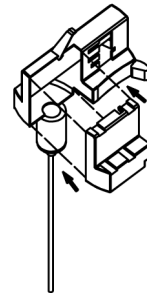

1

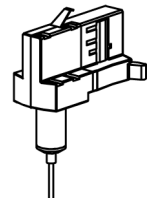

2