

JUNE 3 P





















CODE	COULEUR	KLEUR	FARBE	COLOR	AC	LED	T° (K)	LED Lumen
SU16305	NOIR MAT	MAT ZWART	SCHWARZ MATT	MATT BLACK	AC 230V	50W	2700-3000-4000K	8000 Lm (4000K)
SU16330	BLANC MAT	MAT WIT	WEISS MATT	MATT WHITE	AC 230V	50W	2700-3000-4000K	8000 Lm (4000K)

F Ce produit contient 1 source(s) lumineuse(s) d'efficacité énergétique F.

D Dieses Produkt enthält 1 Lichtquelle(n) mit F Energieeffizienz.

N Dit product bevat 1 lichtbron(nen) energiezuinig F.

E This product contains 1 light source(s) of energy efficiency F.

F	N	D	E
 Montage en suspension.	Pendelmontage.	Nur für Aufhängmontage.	Suspended mounting only.
 Usage intérieur uniquement.	Alleen voor binnengebruik.	Nur für den Innengebrauch.	Indoor use only.
 Protection contre la pénétration des corps solides supérieurs à 1mm. Protection contre les projections d'eau.	Bescherming tegen het binnendringen van lichaam van meer dan 1mm. Bescherming tegen waterspatten.	Schutz gegen Eindringen von Körpern von mehr als 1mm. Schutz gegen Spritzwasser.	Protected against the ingress of solid bodies greater than 1mm. Protected against splashing water.
 Protection contre une énergie de choc de 0,35 Joule.	Bescherming tegen een impact-energie van 0,35 Joule.	Schutz gegen eine Stoßenergie von 0,35 Joule.	Protection against an impact energy of 0,35 Joule.
 Produit à isolation principale qui comporte des dispositifs reliant l'ensemble de ses parties métalliques accessibles au conducteur de protection.	Product met hoofdisolatie, met een apparaat dat alle metalen delen die toegankelijk zijn met de beschermingsleiding verbindt.	Beleuchtung mit Hauptisolierung, mit einem Gerät welches alle seine Metallteile die zugänglich sind mit dem Schutzleiter verbindet.	Earth wire . Fixture equipped with primary insulation only.
 Faisceau 120°.	Lichtbundel 120°.	Strahlwinkel 120°.	Beam 120°.
 Homologation CE.	CE gekeurd.	CE Genehmigung.	Product in conformity CE.
 Température de couleur à sélectionner.	Keuze van kleurtemperatuur.	Wahl der Farbtemperatur.	Selectable colour temperature.
 Risque photobiologique RG1	Fotobiologisch risico RG1	Photobiologisches Risiko RG1	Photobiological risk RG1
 Testé à 650°.	Getest bij 650°.	Getestet bei 650°.	Test on 650°.
 Installation sur surfaces normalement inflammables.	Installatie op normaal ontvlambare oppervlakken.	Installation auf normal entflammbaren Oberflächen.	Suitable for installation on normally flammable surfaces.
 Produit sous haute température en fonctionnement. Interdiction d'avoir des objets ou des parois proches pendant toute la durée de dégagement de chaleur. Même après extinction.	Product onder hoge temperatuur bij werking. Verbot voorwerpen of muren nabij te hebben gedurende de hele oververhitting, zelfs na uitdoving.	Produkt unter hoher Temperatur bei Betrieb. Verbot Gegenstände oder Wände in der Nähe zu haben während der ganzen Dauer der Überhitzung, auch nach dem Erlöschen.	Produkt emitting high temperature. Can not be installed too close of walls and objects even after extinction.
 Attention ! Risque d'électrocution. Extinction de la source électrique avant chaque manipulation.	Let op gevaar voor elektrokuteren. Afsluiten van de stroom voor iedere manipulatie.	Achtung Gefahr eines elektrischen Schlags. Stromquelle abschliessen bevor jede Manipulation.	Attention! Risk of electric shock. Switch off before any intervention on the luminaire.
 Alimentation incluse.	Voeding inbegrepen.	Stromversorgung einbegriffen.	Power supply included.
 Le produit est dimmable.	Het product is dimbaar.	Das Produkt ist dimmbar.	The product is dimmable.
 A connecter à un courant alternatif de 230V.	Aan te sluiten op een AC-circuit van 230V.	An eine AC-Schaltung von 230 Volt an zu schliessen.	To connect to a 230V AC circuit.
 Garantie 5 ans.	5 jaar garantie.	5 Jahre Garantie.	5 years warranty.
 L'appareil doit être éliminé dans des centres de ramassage spécialisés.	Het toestel moet worden afgevoerd in een speciale collectie centra.	Das Gerät muss von einer speziellen Sammelstelle entsorgt werden.	Luminaire must be disposed in specialized collection center.
 Driver remplaçable par un électricien.	Driver vervangbaar door elektricien.	Driver von einem Elektriker austauschbar.	Replaceable control gear by an electrician.
 LED remplaçable par un électricien.	LED vervangbaar door elektricien.	LED von einem Elektriker austauschbar.	Replaceable LED light source by an electrician.
 <ul style="list-style-type: none"> Toutes les sources de chaleur (ampoules, transformateurs, convertisseurs, ...) doivent obligatoirement être suffisamment espacées et ventilées pour empêcher l'incendie. Veuillez nous contacter lors de cas particulier de montage. Ce document doit être conservé pendant toute la durée de vie du produit. Le produit ne sera ni échangé, ni repris en cas d'erreur de montage. INDIGO se réserve le droit de modifier les spécifications sans préavis. <p>Le luminaire doit être monté et installé par un professionnel et il sert uniquement à éclairer.</p>	<ul style="list-style-type: none"> Alle warmtebronnen (lampen, transformatoren, omvormers, ...) moeten voldoende worden geventileerd en op een voldoende afstand zijn om de brand te voorkomen. Neem contact met ons in geval van speciale montage. Dit document moet worden bewaard voor de hele levensduur van het product. Het product wordt nog terug genomen, nog vervangen bij foutieve installatie. INDIGO behoudt zich het recht om specificaties te wijzigen zonder voorafgaande kennisgeving. <p>De armatuur moet worden gemonteerd en geïnstalleerd door vakmensen en dient alleen om te verlichten.</p>	<ul style="list-style-type: none"> Alle Wärmequellen (Lampen, Transformatoren, Umformer, ...) müssen ausreichend belüftet sein und einen genügenden Abstand haben um das Feuer zu verhindern. Bitte kontaktieren Sie uns bei einer speziellen Montage. Dieses Dokument muss für die ganze Lebensdauer des Produkts aufbewahrt Das Produkt wird weder zurückgenommen noch umgetauscht bei falscher Installation. INDIGO behält das Recht für Spezifikationen, ohne vorherige Ankündigung, zu ändern. <p>Die Leuchte darf nur von Fachleuten montiert und installiert werden und dient nur zur Beleuchtung.</p>	<ul style="list-style-type: none"> All heat source (bulbs, transformers, converters, ...) are required to be sufficiently spaced and ventilated to prevent the fire. Please contact us in case of special installation. This document must be kept for the all lifetime of the product. The product can't be returned or exchanged following to installation error. INDIGO reserve the right to modify specifications without prior notice. <p>The fixture should be assembled and installed by professionals and used only to illuminate.</p>

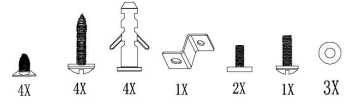
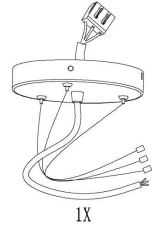
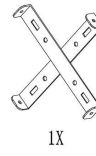
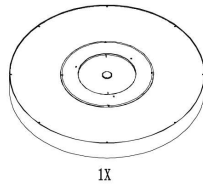
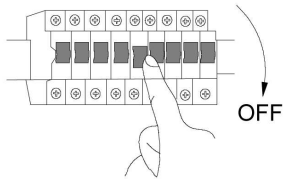

1

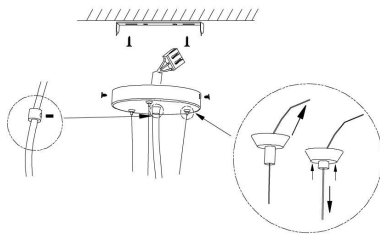

2

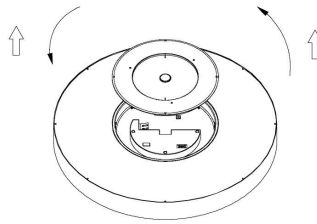

3

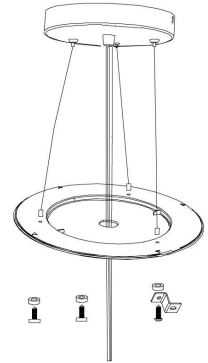

4

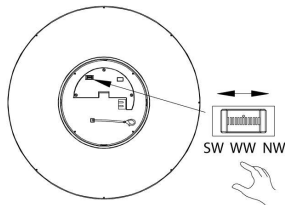

5

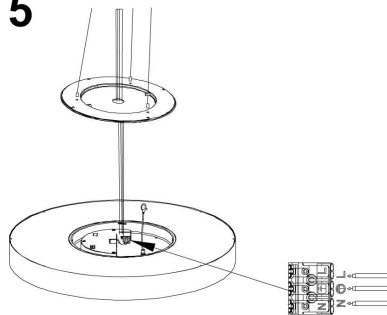

6

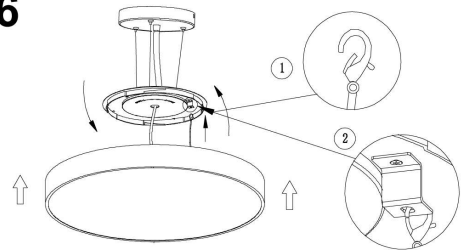

7

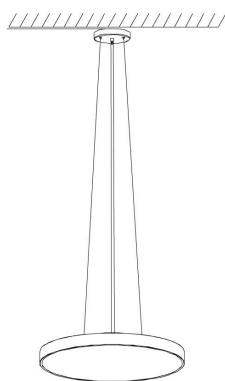

8

