

LIDY A

- Asymmetrical wall lamp for indoor and outdoor lighting.
- 3000K or 4000K as desired via a switch in the luminaire.
- With anti-vandal spanner and screw.
- Non-dimmable converter built in the device.

This product contains 1 light source(s) of energy efficiency E.

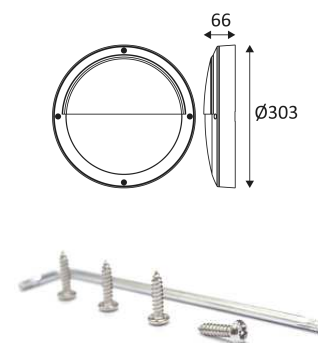















CODE	COLOR	MATERIAL	AC	LED	T° (K)	LED Lumen	System Lumen
BU10305	BLACK	POLYCARBONATE	AC 230V	28W	3000-4000K	4810 Lm (4000K)	2930 Lm (4000K)
BU10330	WHITE	POLYCARBONATE	AC 230V	28W	3000-4000K	4810 Lm (4000K)	2930 Lm (4000K)



BLACK



WHITE

-  Wall mounting only.
-  Indoor and outdoor use.
-  Protected against penetration of dust
Protected against water jets.
-  Protection against an impact energy of 20 Joules.
-  Live parts are equipped with additional isolation protection, such as reinforced or double insulation.
-  Product in conformity CE.
-  CRI >80
-  2 CCT.
3000K
4000K
-  LED specifications.
L70B50
50,000h
-  Photobiological risk RG1
-  Test on 850°.
-  Vandal-resistant.
-  Power supply included.
-  3 years warranty.
-  Photometric data available on our website: www.indigo-lighting.com

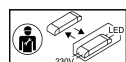
 Replaceable control gear by an electrician.

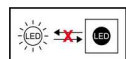
 Non-replaceable light source.